



cargotransport systems

# megarack™ super-sherpa rear bicycle rack

## installation instructions:

Begin by installing the extendable stay mounts onto your MegaRack using four hex-head bolts and nuts (fig.1). Hold the MegaRack up to your bicycles braze-on mounts\* to determine whether you will want to use inside or outside mounting (fig.2). The stay mounts can be mounted to reach up or down depending on the application (fig.3). Tighten the bolts just enough to hold the rack in place yet allow repositioning by hand.

Figure 1

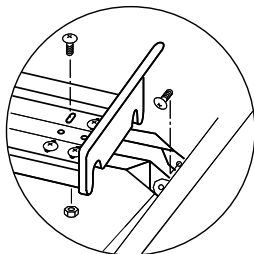
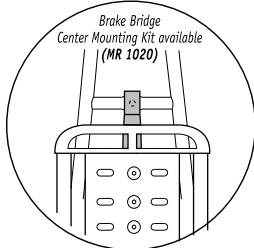
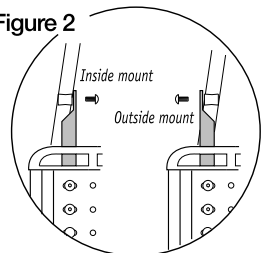

Figure 2



Loosely attach the lower legs of the MegaRack to the tapped holes of your bicycle's rear axle dropouts. It may be necessary to slightly spread MegaRack to fit over the outside of the dropouts. Do not tighten yet.

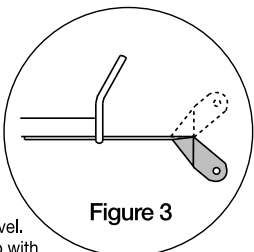
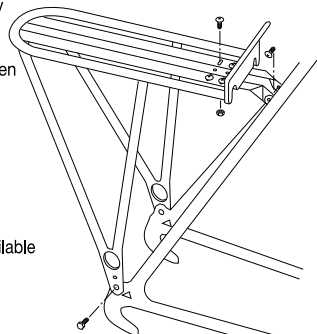

Figure 3

Position MegaRack so its top plate is level. Extend the stay mounts until they line up with the braze-ons. It may be necessary to gently bend the stay-mounts for some bicycles. Fasten with two hex head bolts. You may now tighten the other bolts in the stay mounts.

- For bicycles without braze-ons, use Delta frame clamps. These are available to fit standard 5/8" tubing (MR1030) or oversize 7/8" (MR1040). Brake bridge mounting kits also available (MR1020).



**WARNING: This rack should never be used as a seat or to carry passengers.**

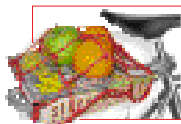

Use with Delta Cargo Net to carry just about anything

MR100 MegaRack (Black)



Δ.A. by  
Delta Cycle Corporation

P.O. Box 628, Foxborough, MA 02035 USA  
Manufactured in China and Taiwan.

7 99403 20830 3

MR100S MegaRack (Silver)



7 99403 20835 8



cargotransport systems

# megarack™ super-sherpa rear bicycle rack

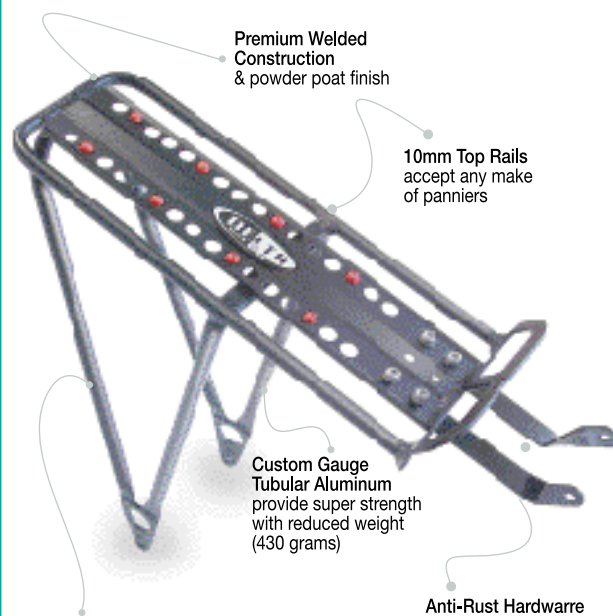

∞ Lifetime Warranty



Rubber Grippers  
Keep loads in place



Extra Versatility  
with threaded eyelets

[www.deltacycle.com](http://www.deltacycle.com)

Silver PMS 877

Aqua rules are die lines  
do not print